

NOTES:

- 1. IC1 IS A TLO 72
- 2. UNLESS OTHERWISE NOTED - ALL RESISTORS ARE 1/4W.

CARVER CORPORATION		
PM-1.5 INPUT BOARD		
M. LIENO	11-83	
REV A		

601 00132-01

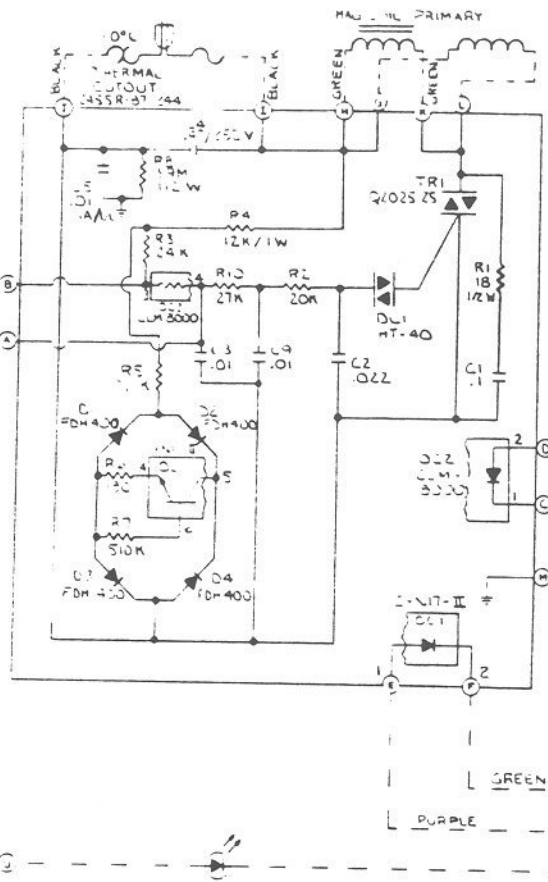
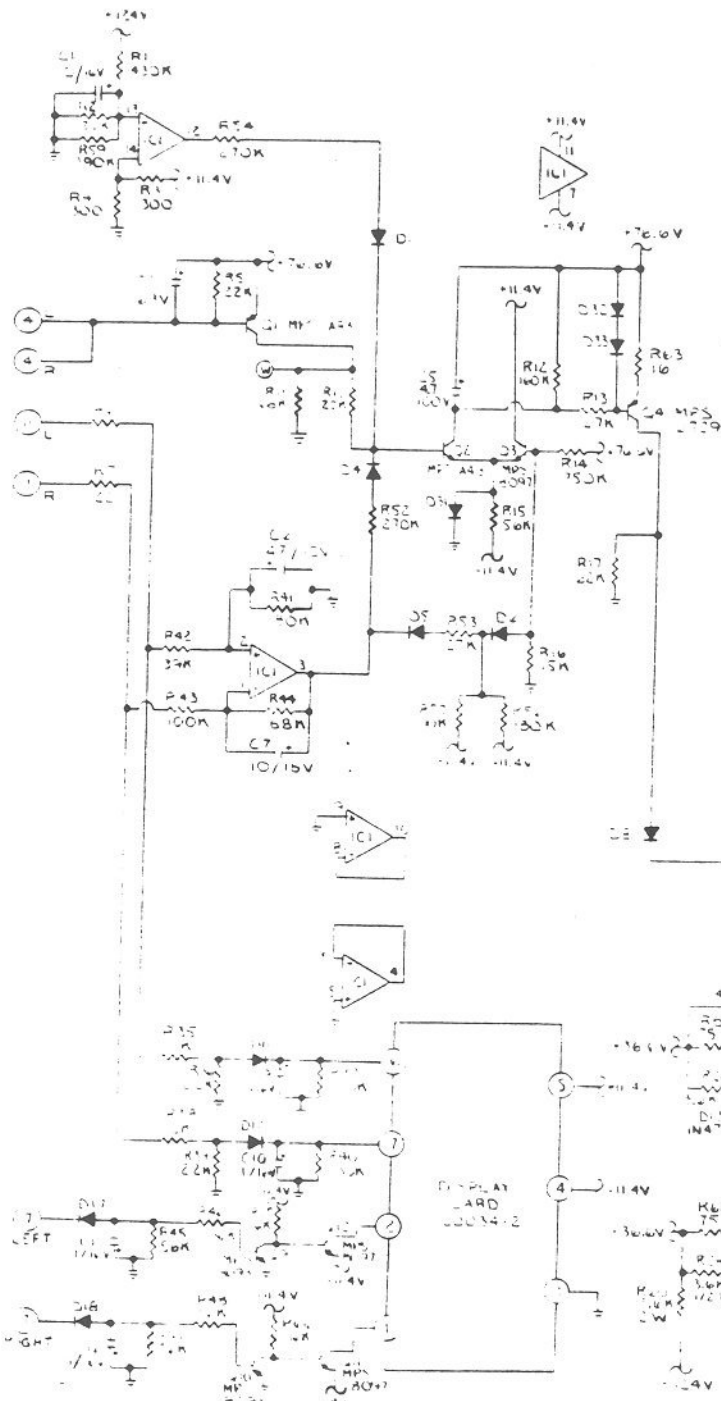

CARVER CORPORATION	
PROJECT NO. 601-00127-01	REV. PWR SUPPLY PMIS 0V
	24V P.R.K. REGULATOR PMIS 100V
	DATE: 10/15/60
	BY: R. J. ...
	601-00127-01

- REVISED AND REDRAWN 7/1/65 (PMI)
- NOTES: UNLESS OTHERWISE SPECIFIED:
1. ALL RESISTORS ARE 1/4 W.
 2. ALL DIODES ARE IN4148.
 3. ALL CAPACITANCE IS IN UF.
 4. C3 AND C4 ARE DUAL 220UF, 50/80V CAPS.
 5. IC1 IS A 9130.

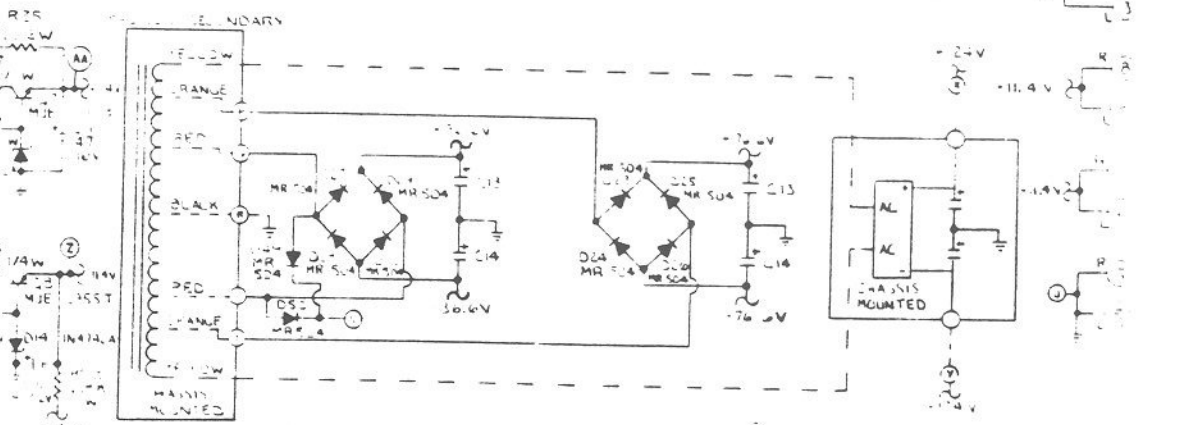
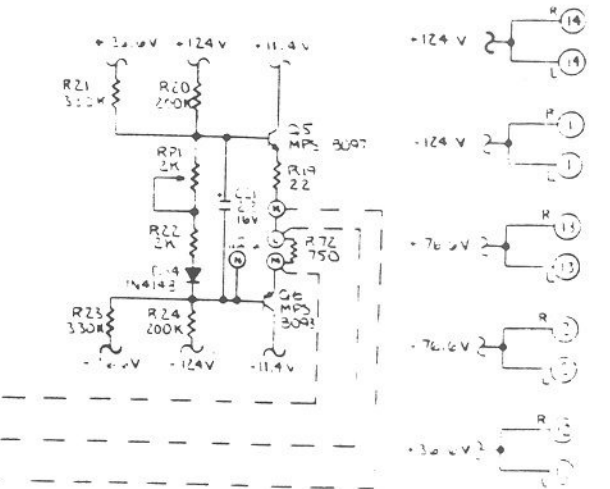
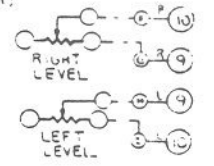

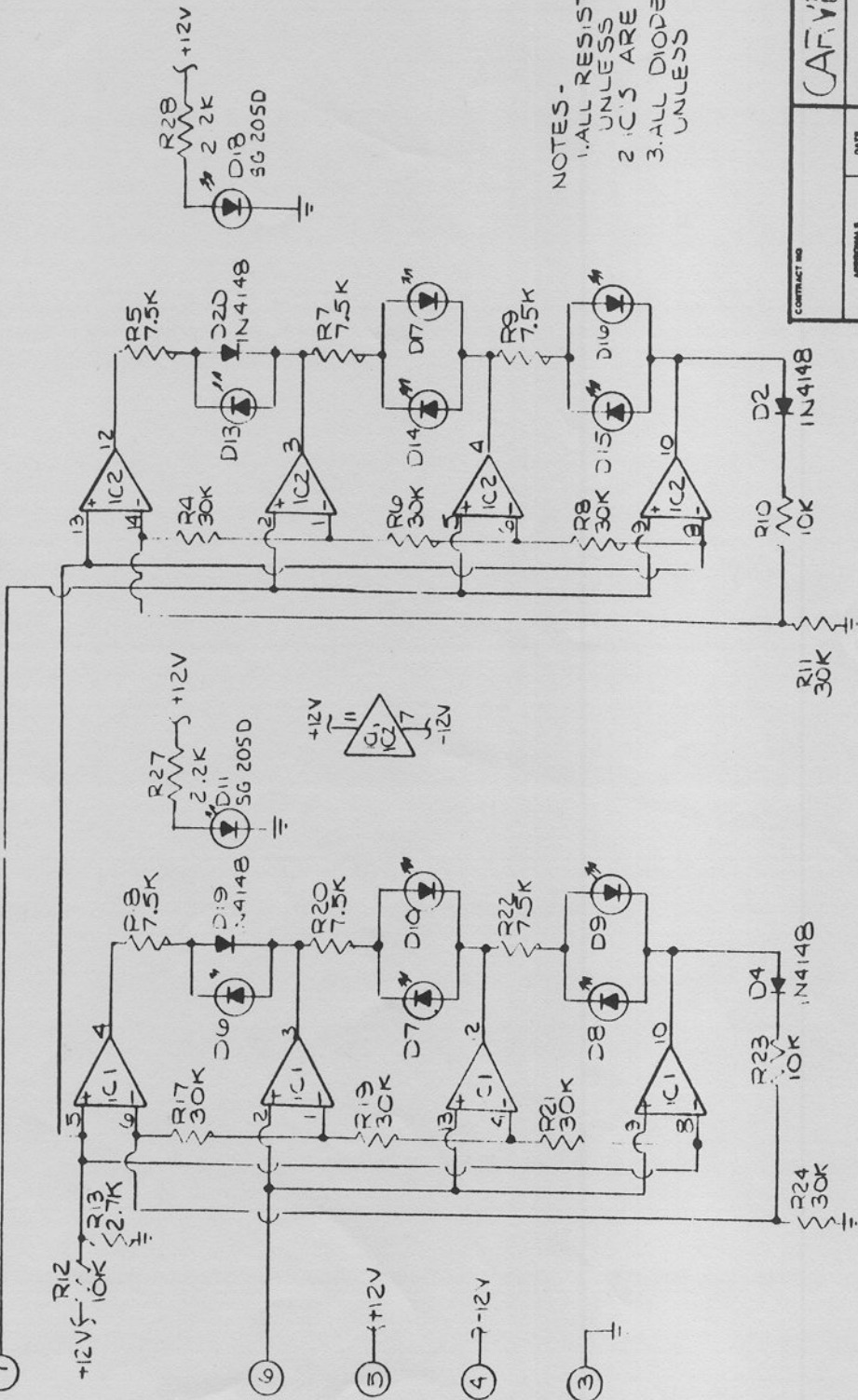
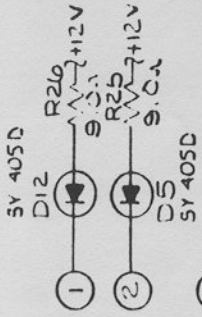

NOTES -
 1. ALL RESISTORS ARE 1/4 WATT UNLESS NOTED.
 2. IC'S ARE 4136
 3. ALL DIODES ARE SR505W UNLESS NOTED.

CONTRACT NO.		DATE	
APPROVALS		DATE	
DESIGNED BY ME LENO		1-18-83	
CHECKED BY H. H. L. T.		1-1-83	
SCALE		DRAWING NO.	
B		601-00128-C	
SHEET		OF	
1		1	

CARVEL CORPORATION
 PM 1.5 DISPLAY

601-00128-01